



ICAP/4Rx

Can Your SPICE Program Do All Of This? Compare and Save!

Functionality you need at a decisively LOW PRICE!

If you're looking for an easy to use and very affordable analog and mixed-signal design simulation package, then ICAP/4Rx is for you. ICAP/4Rx features full simulation power, but less advanced production verification analyses.

ICAP/4Rx seamlessly integrates ICAP/4's schematic entry system (SpiceNet), the IsSpice4 4th-generation simulation kernel, a powerful interactive waveform viewing and processing tool (IntuScope), and a wide variety of 15,500+ part models. An intuitive user interface eliminates the need to learn SPICE syntax or hunt for ways of performing design entry and simulation functions. Analysis and convergence wizards remove the guess work from simulation setup, or resolving convergence issues on rigorous design topologies. Plenty of instant in-application help is also available. Get up to speed quickly with movies and printed manuals that walk you through the software.

IsSpice4 is the industry's leading Berkeley SPICE 3F.5 and XSPICE based technology, but with countless enhancements for optimizing DC convergence, simulation accuracy and speed. You can perform AC, DC, DC sweep, transient, operating point, Fourier, pole-zero and temperature analyses on circuits of unlimited size. SpiceNet enables cross-probing of any node voltage, or device current and power dissipation. You can display a thumbnail waveform on the schematic or a detailed plot in IntuScope. Similarly, press a button to view on the schematic all operating point information throughout the design. You can even create custom artwork right on the drawing.

IntuScope allows you to plot data from many sources such as IsSpice4 simulation, linearized data saved in the .OUT file, .CSDF data from another program, or any delimited text file of data points. Interpolation is automatic, so once plotted you can instantly perform waveform math on any waveform from any source. You can use an unlimited number of measurement cursors and drag and drop them between waveforms to make relative measurements.

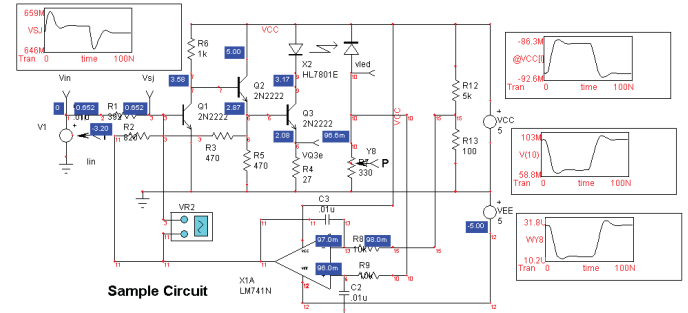

The SpiceNet schematic capture interface is very easy to use. Press "R" for resistor, "L" for inductor, "C" for capacitor and "V" for voltage source. Use the powerful parts browser to quickly access 15,100 parts for placement or editing. Hold down <Shift> key and click on parts to add or remove them from your selections. Draw a bounding box around parts to select them and instantly group rotate or flip them. Double click on any part and a dialog will show all parameters for easy editing.

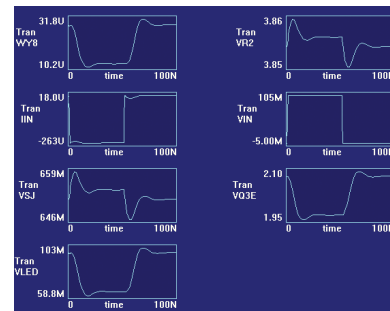

Watch real-time marching waveforms everywhere a test point is placed. Test point names are automatically assigned, based on the part or node it is connected to. Or, you can assign a desired name.

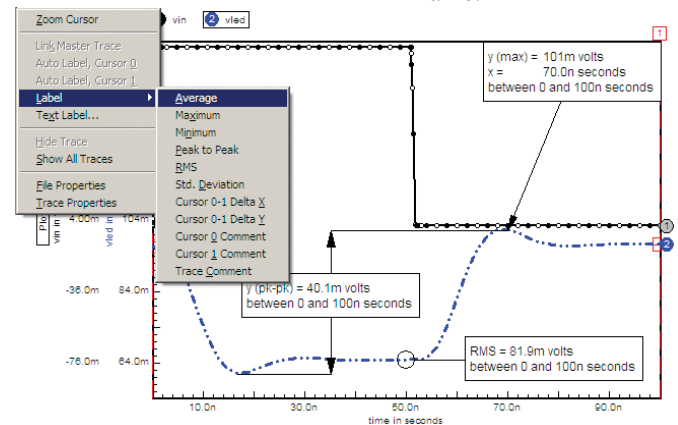

The intuScope interface is very easy to use. More than 125 waveform processing functions (calculator) are provided from menu pulldowns. Click on any two waveforms and press +, -, /, or * to perform waveform math. Move cursors to an area of interest and press "x" to expand the x-axis scale to that interval. Drag and drop waveforms between plots. Hold down <Shift> key to select multiple waveforms and change all their scales at once. Move cursors to an area of interest, then right mouse click on graph and choose average, maximum, peak to peak, or RMS to instantly display value on graph between cursors.

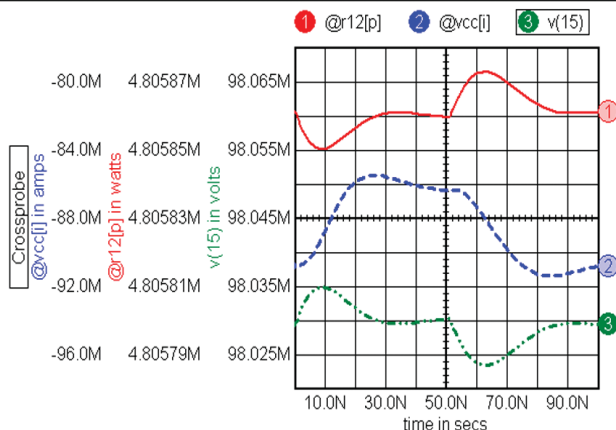

IntuScope enables signal plots to be customized with many different line styles, colors and text labels.

ICAP/4Rx Makes Simulation Effortless!

Easy, Affordable and Upgradeable

- Quickly get up and running with an extensive in-application help system, movies and softbound manuals.
- Receive all software upgrades and technical support free for a year.
- 30-day money back guarantee and low-cost upgrade path to the advanced ICAP/4Windows software.

Simulation Environment

- IsSpice4: Vastly enhanced SPICE 3F5 and XSPICE based simulation kernel provides big gains in DC convergence, simulation accuracy and speed.
- AC, transient, operating point, DC sweep, Fourier, temperature and pole-zero analysis provided.
- Sweep a passive component value, semiconductor's temperature or global circuit temperature to create a curve family.
- Use ICAP/4's *exclusive* simulator options like VSECTOL, AUTOTOL, and ICSTEP for faster convergence.
- Control your simulation through scripts. Stop simulation if value reached, incrementally change any circuit parameter and then re-simulate design, all with no user interaction. Use script commands like let, if-then-else, repeat and stop when.
- Observe simulation progress with real-time marching waveforms. Instantly stop simulation with a push of a button.

Elements and Models

- 15,500+ models, including 600+ digital parts and 200 model types. Nonlinear magnetic, SCR, IGBT, PWM (average), MOV, lamp, fuse, thermistor, pressure sensor, photo/laser diode, 2,500+ vendor IC models and configurable generic models.
- Variety of MOSFET (latest BSIM3, BSIM4 & SOI) and MESFET models (Anadigics, HEMT, Statz Parker-Skellern, Curtis-Enttenberg)
- Lossy transmission lines and switches with hysteresis.
- Behavioral Modeling: math expression, Boolean, if-then-else & table.
- Resistors, capacitors and inductors accept expressions. Use trigonometric functions; passed parameters; and simulation time, frequency, or circuit temperature in an expression.

Graphics and Post Processing

- Draw a complete schematic that's configurable using circuit overlays, easily wired together and selectively highlighted from the composite design.
- Cross-probing displays waveforms instantly on schematic and in the IntuScope waveform viewer.
- Operating points, waveforms and custom artwork displayed directly on the schematic. Copy/paste schematic or waveform graph into any publication for documentation purposes.
- Instantly update previous waveform data by overwriting old waveforms, appending to them, or creating a new graph.
- Save graph including special labels "as script" on drawing. In the future, run script to reenact entire waveform environment, and with new plots if design changes are made.
- Plot waveforms from multiple data sources all on the same graph, then perform waveform math on them.

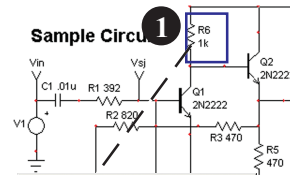

Create a curve family

- (1) Select a device to sweep.
- (2) Enter the sweep values.
- (3) Create a list of waveforms to plot for each swept value.
- (4) Press Run. IsSpice4 conserves data from initial run for faster sweeping.

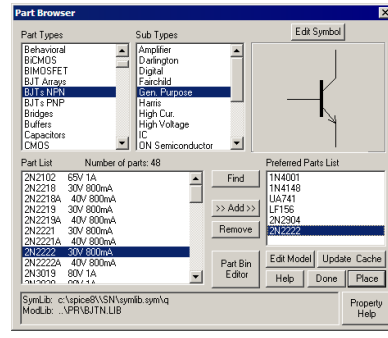
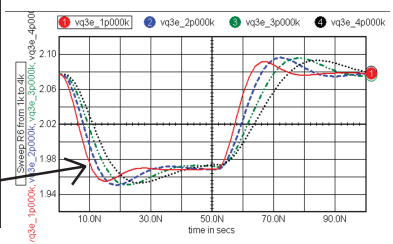
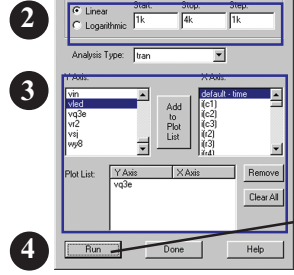

Easy Part Browser

ICAP/4Rx's hierarchical parts browser makes finding parts easy. Search by part number, model name, part type, subtype or description.

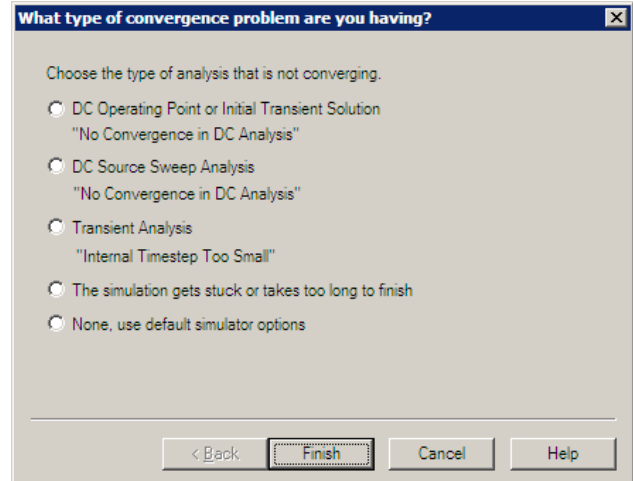

Use wizards to setup your analysis and overcome tough convergence problems.

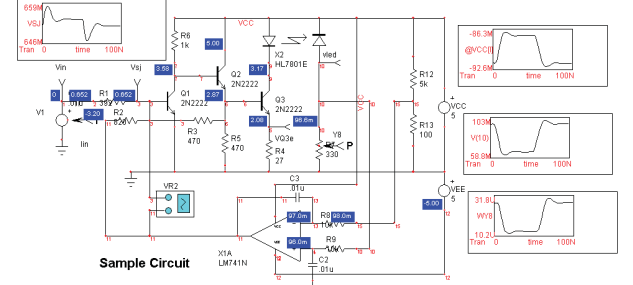

Cross-probe any node voltage, or device current and power, to display the waveform on the schematic or in the IntuScope waveform viewer.